

18-75V Continuous Input	15V Output	6.67A Current	100W Max Power	2000V dc Isolation	Quarter-brick DC-DC Converter
-----------------------------------	----------------------	-------------------------	--------------------------	------------------------------	---

PowerQor®

The PQ40150QGx07 PowerQor® Giga quarter-brick converter is a next-generation, board-mountable, isolated, fixed switching frequency DC/DC converter that uses synchronous rectification to achieve extremely high conversion efficiency. The power dissipated by the converter is so low that a heatsink is not required, which saves cost, weight, height, and application effort. All of the power and control components are mounted to the multi-layer PCB substrate with highyield surface mount technology for greater reliability. The PQ40 module offers a wide input voltage range to cover both 24V and 48V applications. RoHS compliant, see last page.

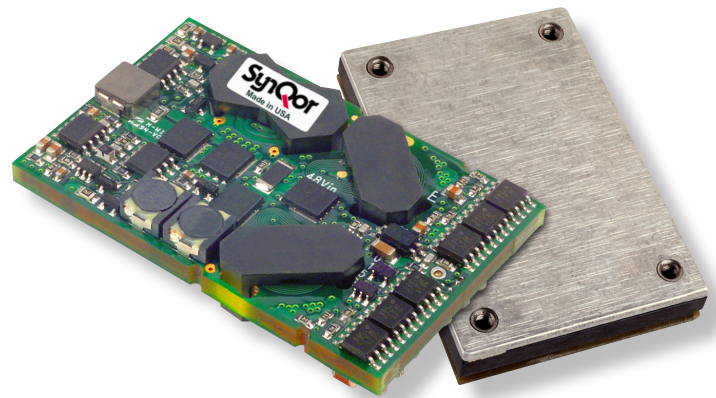

PQ40150QGx07 Module

Operational Features

- High efficiency, >90% at full rated load current
- Delivers up to 6.67A of output current (100W) with minimal derating - no heatsink required
- Ultra wide input voltage range: 18V – 75V, with 100V 100ms input voltage transient capability
- Fixed frequency switching provides predictable EMI performance
- No minimum load requirement means no preload resistors required.

Mechanical Features

- Industry standard pin-out configuration
- Standard Size: 2.30"x1.45"x0.397" (58.4x36.8x10.08mm)
- Weight: 1.2 oz. (34 grams)
- Flanged pins designed to permit surface mount soldering, avoid wave solder using FPIP technique on open frame units

Control Features

- On/Off control referenced to input side (positive and negative logic options are available)
- Remote sense for the output voltage compensates for output distribution drops
- Output voltage trim permits custom voltages and voltage margining

Protection Features

- Input under-voltage lockout disables converter at low input voltage
- Output current limit and short circuit protection protects converter from excessive load current or short circuits
- Active back bias limit prevents damage to converter from external load induced pre-bias
- Output over-voltage protection protects load from damaging voltages
- Thermal shutdown protects converter from abnormal environmental conditions

Safety Features

- CAN/CSA C22.2 No. 60950-1
- UL 60950-1
- EN 60950-1

Contents

	Page No.
Mechanical Diagrams	2
Electrical Characteristics	4
Figures	6
Application Section	11
Ordering Information	16

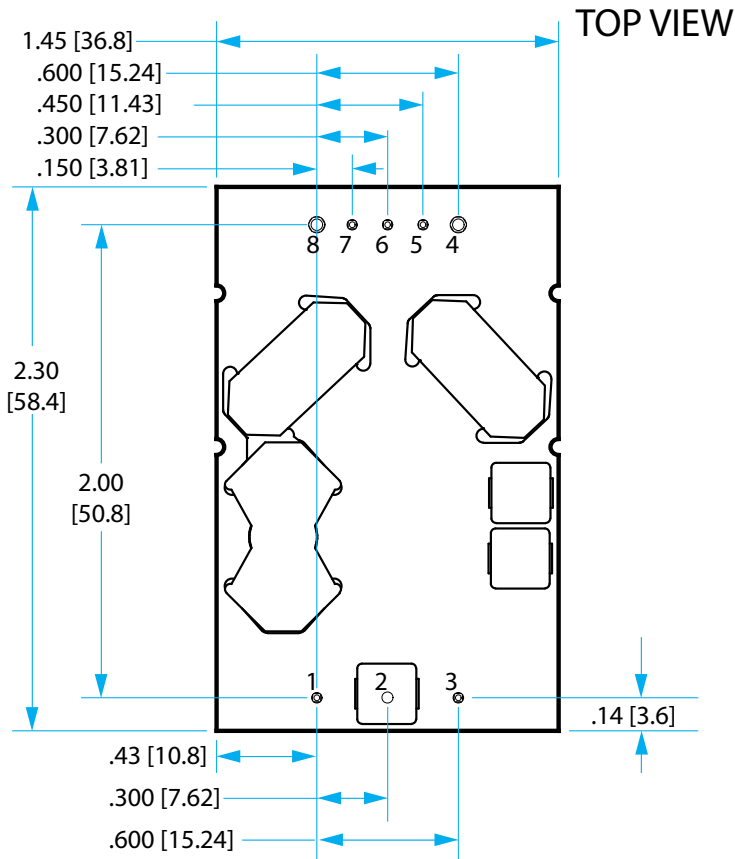

SIDE VIEW

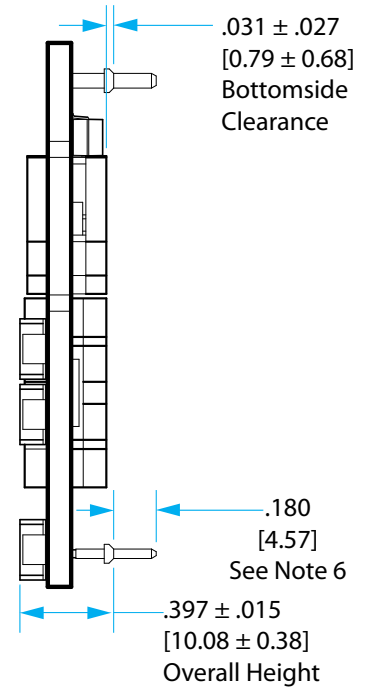

NOTES

- 1) Pins 1-3, 5-7 are 0.040" (1.02mm) diameter, with 0.080" (2.03mm) diameter standoff shoulders.
- 2) Pins 4 and 8 are 0.062" (1.57 mm) diameter with 0.100" (2.54 mm) diameter standoff shoulders.
- 3) Other pin extension lengths available.
- 4) All Pins: Material - Copper Alloy- Finish - Matte Tin over Nickel plate
- 5) Undimensioned components are shown for visual reference only.
- 6) Weight: 1.2 oz. (34 grams)
- 7) All dimensions in inches (mm)
 Tolerances: x.xx in +/-0.02 in. (x.xmm +/-0.5 mm)
 x.xxx in +/-0.010 in. (x.xxmm +/-0.25 mm)

PIN DESIGNATIONS

Pin	Name	Function
1	Vin(+)	Positive input voltage
2	ON/OFF	TTL input to turn converter on and off, referenced to Vin(-), with internal pull up.
3	Vin(-)	Negative input voltage
4	Vout(-)	Negative output voltage
5	SENSE(-)	Negative remote sense (See note 1)
6	TRIM	Output voltage trim (See note 2)
7	SENSE(+)	Positive remote sense (See note 3)
8	Vout(+)	Positive output voltage

Notes:

- 1) SENSE(-) should be connected to Vout(-) either remotely or at the converter.
- 2) Leave TRIM pin open for nominal output voltage.
- 3) SENSE(+) should be connected to Vout(+) either remotely or at the converter.

TOP VIEW

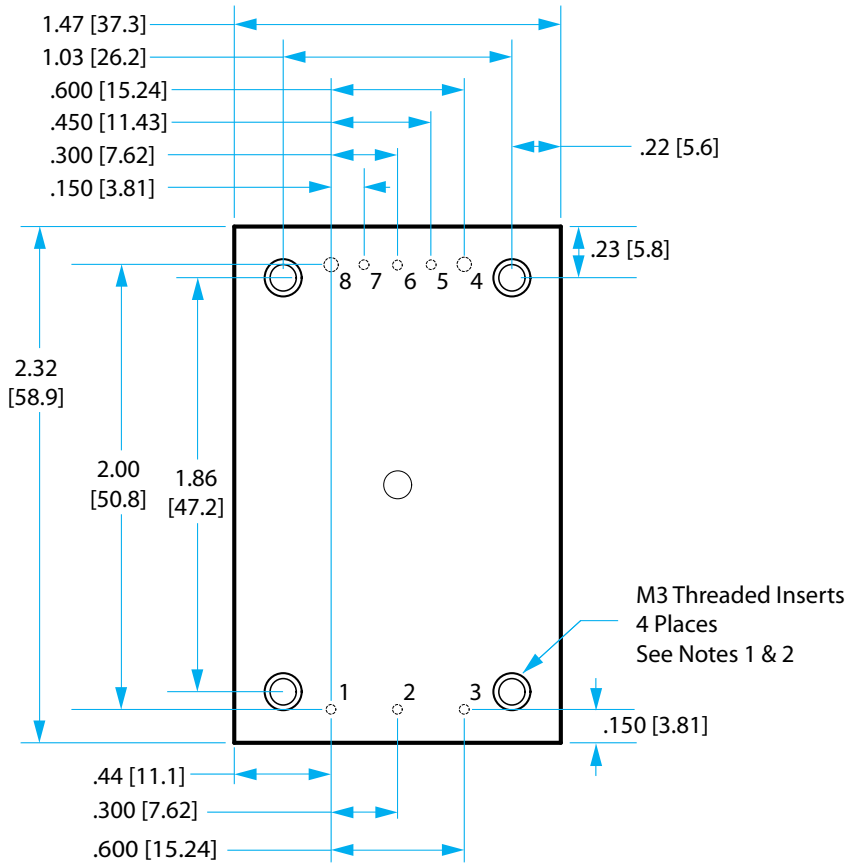

SIDE VIEW

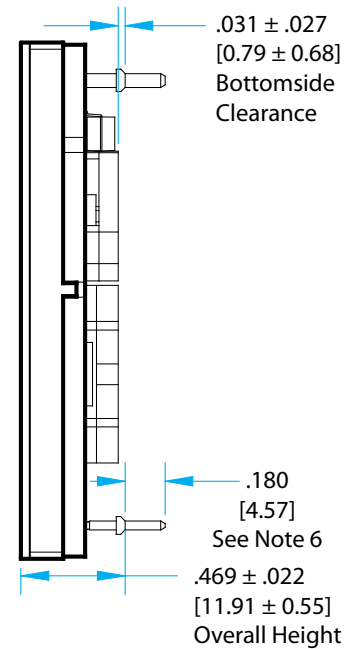

NOTES

- 1) M3 screws used to bolt unit's baseplate to other surfaces (such as a heatsink) must not exceed 0.100" (2.54 mm) depth below the surface of the baseplate.
- 2) Applied torque per screw should not exceed 6in-lb. (0.7 Nm).
- 3) Baseplate flatness tolerance is 0.004" (.10mm) TIR for surface.
- 4) Pins 1-3, 5-7 are 0.040" (1.02mm) diameter, with 0.080" (2.03mm) diameter standoff shoulders.
- 5) Pins 4 and 8 are 0.062" (1.57 mm) diameter with 0.100" (2.54 mm) diameter standoff shoulders.
- 6) Other pin extension lengths available. Recommended pin length is 0.03" (0.76mm) greater than the PCB thickness.
- 7) All Pins: Material - Copper Alloy- Finish - Matte Tin over Nickel plate
- 8) Undimensioned components are shown for visual reference only.
- 9) Weight: 2.15 oz. (60.9 g) typical
- 10) All dimensions in inches (mm)

Tolerances: x.xx in +/-0.02 in. (x.xmm +/-0.5 mm)
 x.xxx in +/-0.010 in. (x.xxmm +/-0.25 mm)

PIN DESIGNATIONS

Pin	Name	Function
1	Vin(+)	Positive input voltage
2	ON/OFF	TTL input to turn converter on and off, referenced to Vin(-), with internal pull up.
3	Vin(-)	Negative input voltage
4	Vout(-)	Negative output voltage
5	SENSE(-)	Negative remote sense (See note 1)
6	TRIM	Output voltage trim (See note 2)
7	SENSE(+)	Positive remote sense (See note 3)
8	Vout(+)	Positive output voltage

Notes:

- 1) SENSE(-) should be connected to Vout(-) either remotely or at the converter.
- 2) Leave TRIM pin open for nominal output voltage.
- 3) SENSE(+) should be connected to Vout(+) either remotely or at the converter.

PQ40150QGx07 Electrical Characteristics

Ta = 25 °C, airflow rate = 300 LFM, Vin = 48V dc unless otherwise noted; full operating temperature range is -40 °C to +100 °C baseplate temperature with appropriate power derating. Specifications subject to change without notice.

Parameter	Min.	Typ.	Max.	Units	Notes & Conditions
ABSOLUTE MAXIMUM RATINGS					
Input Voltage					
Non-Operating	-1		100	V	Continuous
Operating			80	V	Continuous
Operating Transient Protection			100	V	100ms transient, square wave
Isolation Voltage					
Input to Output			2000	V	Basic insulation, Pollution Degree 2
Operating Temperature	-40		100	°C	
Storage Temperature	-55		125	°C	
Voltage at ON/OFF input pin	-2		18	V	
INPUT CHARACTERISTICS					
Operating Input Voltage Range	18	48	75	V	
Input Under-Voltage Lockout					
Turn-On Voltage Threshold	16.0	16.7	17.4	V	
Turn-Off Voltage Threshold	14.4	15.1	15.8	V	
Lockout Voltage Hysteresis	1.1	1.6	2.1	V	
Maximum Input Current			6.17	A	100% Load, 18Vin
No-Load Input Current		80	160	mA	
Disabled Input Current		2.0	4	mA	
Inrush Current Transient Rating			0.03	A ² s	
Response to Input Transient		350		mV	1000V/ms input transient, 48V-75V step
Input Reflected Ripple Current		5		mA	P-P thru 10µH inductor; Figures 17 & 19
Input Terminal Ripple Current		145		mA	RMS; Figures 17 & 18
Recommended Input Fuse			20	A	Fast acting external fuse recommended
Input Filter Component Values (L\C)		1.5 \ 6.6		µH\µF	Internal values; Figure E
Recommended External Input Capacitance		47		µF	Typical ESR 0.1-0.2Ω; Figure 17
OUTPUT CHARACTERISTICS					
Output Voltage Set Point	14.77	15.00	15.23	V	
Output Voltage Regulation					
Over Line		±0.04 \ 6	±0.2 \ 30	% \ mV	
Over Load		±0.04 \ 6	±0.2 \ 30	% \ mV	
Over Temperature		±112	±300	mV	
Total Output Voltage Range	14.47		15.54	V	Over sample, line, load, temperature & life
Output Voltage Ripple and Noise					20MHz bandwidth; Figures 17 & 20
Peak-to-Peak		75	150	mV	Full Load, 1µF ceramic, 10µF tantalum
RMS		15	30	mV	Full Load, 1µF ceramic, 10µF tantalum
Operating Output Current Range	0		6.67	A	Subject to thermal derating; Figures 5 - 12
Output DC Current-Limit Inception	7	8	9	A	Output Voltage 10% Low; Figure 21
Output DC Current-Limit Shutdown Voltage		13.2		V	
Back-Drive Current Limit while Enabled	0.1	0.3	0.8	A	Negative current drawn from output
Back-Drive Current Limit while Disabled	0	10	50	mA	Negative current drawn from output
Maximum Output Capacitance			2,000	µF	15Vout at 6.7A Resistive Load
EFFICIENCY					
100% Load (24Vin)		90		%	Figures 1 - 4, 24Vin
50% Load (24Vin)		91		%	Figures 1 - 4, 24Vin
100% Load (48Vin)		89		%	Figures 1 - 4, 48Vin
50% Load (48Vin)		90		%	Figures 1 - 4, 48Vin

PQ40150QGx07 Electrical Characteristics (continued)

Ta = 25 °C, airflow rate = 300 LFM, Vin = 48V dc unless otherwise noted; full operating temperature range is -40 °C to +100 °C baseplate temperature with appropriate power derating. Specifications subject to change without notice.

Parameter	Min.	Typ.	Max.	Units	Notes & Conditions
DYNAMIC CHARACTERISTICS					
Input Voltage Ripple Rejection		45		dB	120 Hz; Figure 24
Output Voltage during Load Current Transient					
Step Change in Output Current (0.1A/μs)		190		mV	50% to 75% to 50% Iout max; Figure 15
Step Change in Output Current (5A/μs)		190		mV	50% to 75% to 50% Iout max; Figure 16
Settling Time		700		μs	To within 1% Vout nominal
Turn-On Transient					
Turn-On Time	4	8	16	ms	Full load, Vout=90% nom; Figures 13 & 14
Start-Up Inhibit Period	180	200	240	ms	-40°C to +125°C; Figure F
Output Voltage Overshoot		0		%	
TEMPERATURE LIMITS FOR POWER DERATING CURVES					
Semiconductor Junction Temperature			125	°C	Package rated to 150°C
Board Temperature			125	°C	UL rated max operating temp 130°C
Transformer Temperature			125	°C	See Figures 5 - 12 for derating curves
ISOLATION CHARACTERISTICS					
Isolation Voltage (dielectric strength)		2000		V	
Isolation Resistance		30		MΩ	
Isolation Capacitance		470		pF	See Note 2
FEATURE CHARACTERISTICS					
Switching Frequency	291	315	340	kHz	Regulation stage and Isolation stage
ON/OFF Control (Option P)					
Off-State Voltage	-2		0.8	V	
On-State Voltage	2.4		18	V	
ON/OFF Control (Option N)					
Off-State Voltage	2.4		18	V	
On-State Voltage	-2		0.8	V	
ON/OFF Control (Either Option)					Application notes; Figures A & B
Pull-Up Voltage		Vin/4.25	17.7	V	
Pull-Up Resistance		33		kΩ	
Output Voltage Trim Range	-20		+10	%	Measured across Pins 8 & 4; Figures 27 & C
Output Voltage Remote Sense Range			+10	%	Measured across Pins 8 & 4; Figure 27
Output Over-Voltage Protection	117	122	127	%	Over Full Temperature Range; % of nominal Vout
Over-Temperature Shutdown		125		°C	Average PCB Temperature
Over-Temperature Shutdown Restart Hysteresis		10		°C	
Load Current Scale Factor		1000			See App Note: Output Load Current Calculations
RELIABILITY CHARACTERISTICS					
Calculated MTBF (Telcordia)		2.50		10 ⁶ Hrs.	TR-NWT-000332; 80% load, 300LFM, 40°C Ta
Calculated MTBF (MIL-217)		1.56		10 ⁶ Hrs.	MIL-HDBK-217F; 80% load, 300LFM, 40°C Ta
Field Demonstrated MTBF				10 ⁶ Hrs.	See our website for details

Note 1: For applications requiring reduced output voltage ripple and noise, consult SynQor applications support (e-mail: support@synqor.com)

Note 2: Higher values of isolation capacitance can be added external to the module.

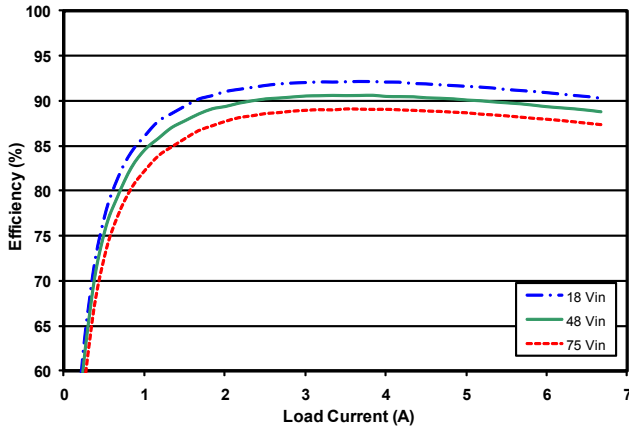

Figure 1: Efficiency at nominal output voltage vs. load current for 18V, 48V and 75V input at 25°C.

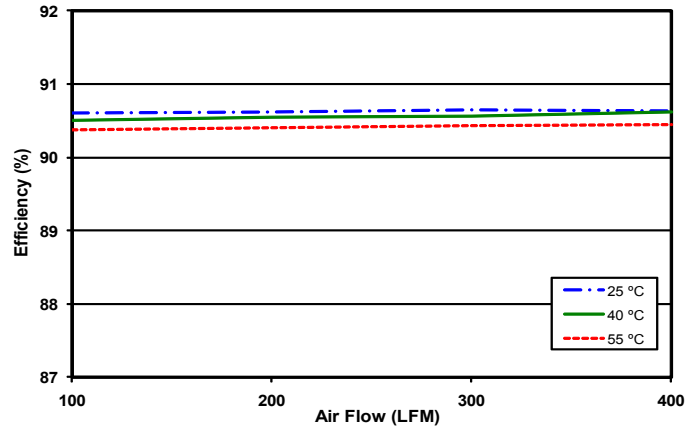

Figure 2: Efficiency at nominal output voltage and 60% rated power vs. airflow rate for ambient air temperatures of 25°C, 40°C, and 55°C (nominal input voltage, 48V input).

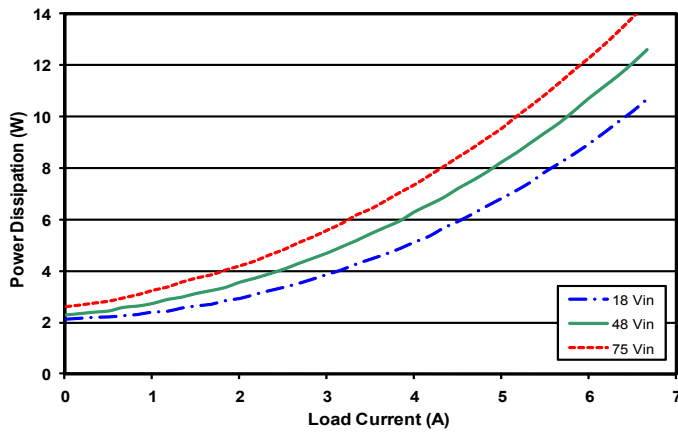

Figure 3: Power dissipation at nominal output voltage vs. load current for 18V, 48V and 75V input at 25°C.

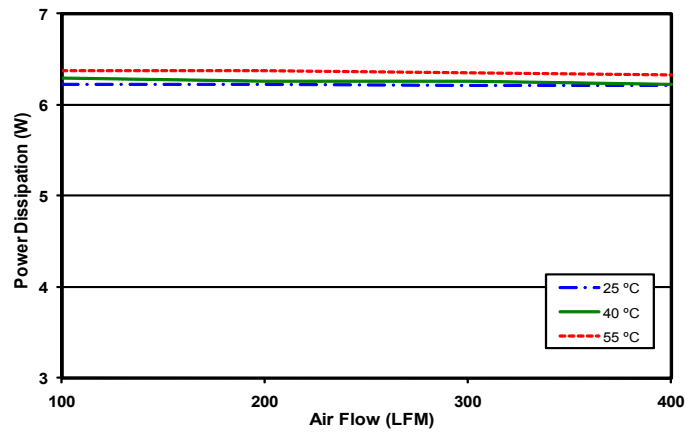

Figure 4: Power dissipation at nominal output voltage and 60% rated power vs. airflow rate for ambient air temperatures of 25°C, 40°C, and 55°C (nominal input voltage, 48V input).

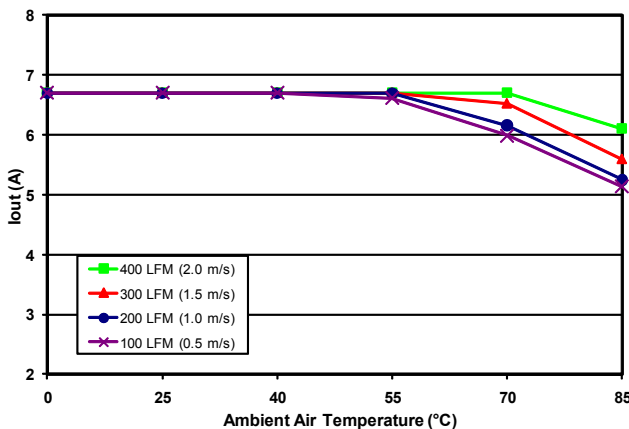

Figure 5: Maximum output power derating curves vs. ambient air temperature for airflow rates of 100 LFM through 400 LFM with air flowing across the converter from pin 3 to pin 1 (24V input).

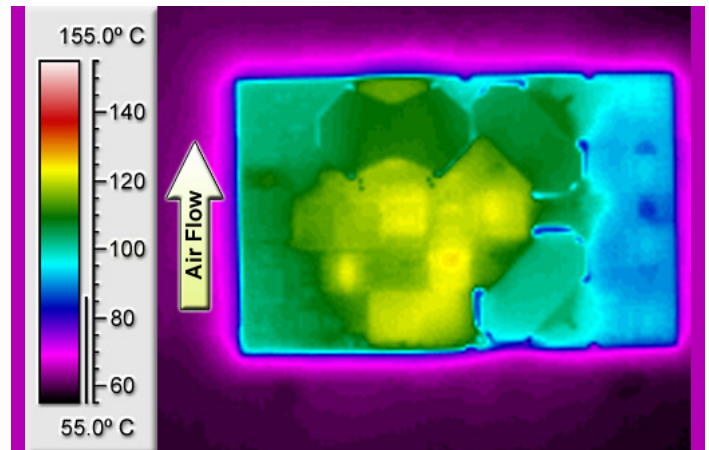

Figure 6: Thermal plot of converter at 6.7 amp load current with 55°C air flowing at the rate of 200 LFM. Air is flowing across the converter sideways from pin 3 to pin 1 (24V input).

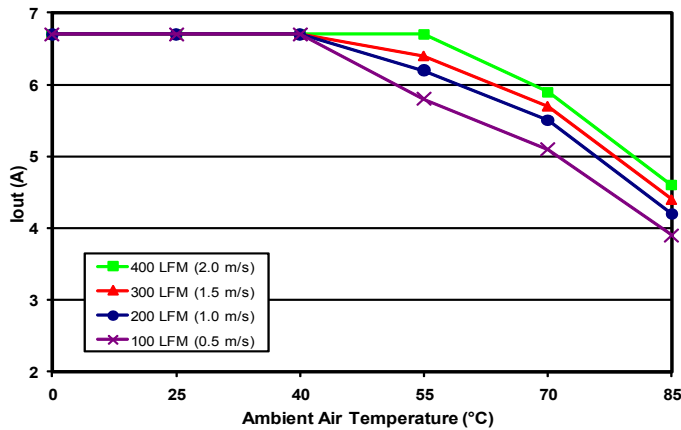

Figure 7: Maximum output power derating curves vs. ambient air temperature for airflow rates of 0 LFM through 400 LFM with air flowing from pin 3 to pin 1 (48V input).

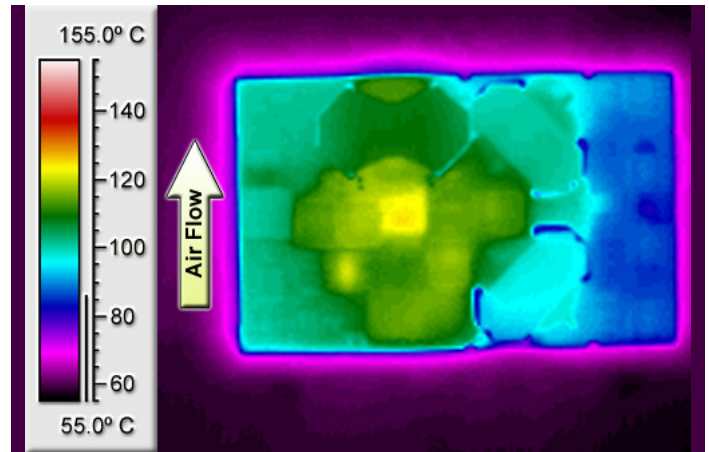

Figure 8: Thermal plot of converter at 6.2 amp load current with 55°C air flowing at the rate of 200 LFM. Air is flowing across the converter sideways from pin 3 to pin 1 (48V input).

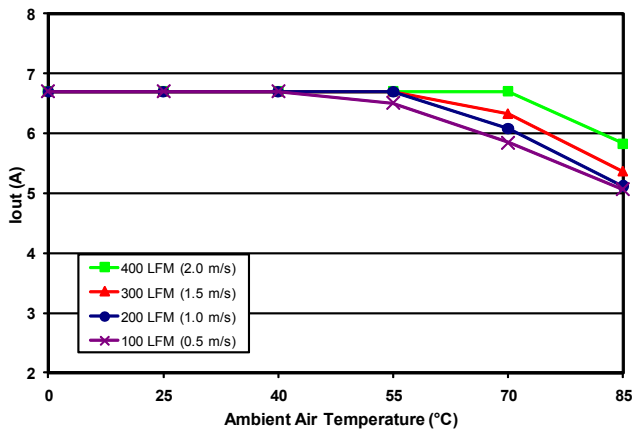

Figure 9: Maximum output power-derating curves vs. ambient air temperature for airflow rates of 100 LFM through 400 LFM with air flowing from input to output (24V input).

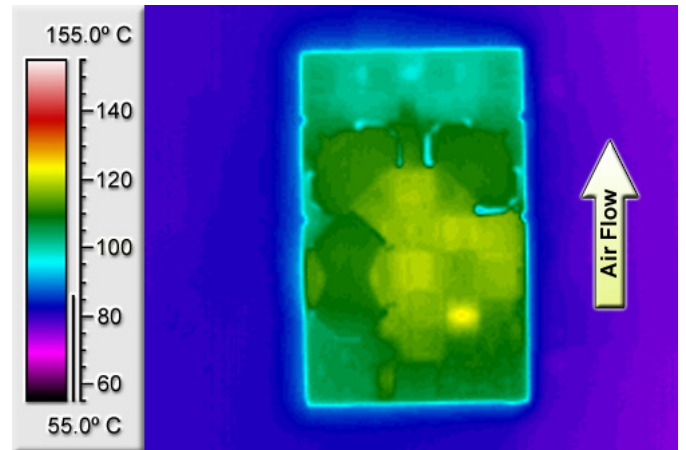

Figure 10: Thermal plot of converter at 5.1 amp load current with 85°C air flowing at the rate of 200 LFM. Air is flowing across the converter from input to output (24V input).

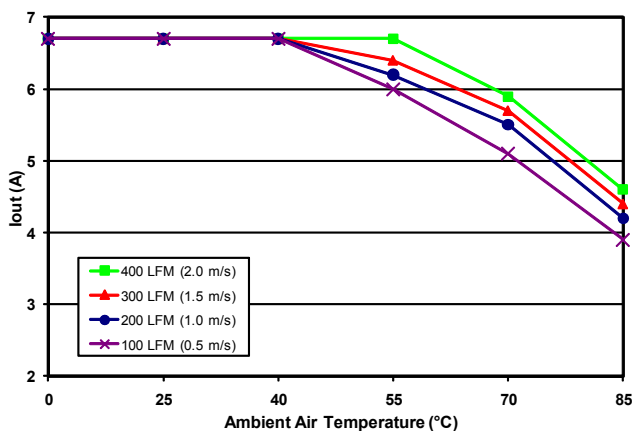

Figure 11: Maximum output power-derating curves vs. ambient air temperature for airflow rates of 100 LFM through 400 LFM with air flowing from input to output (48V input).

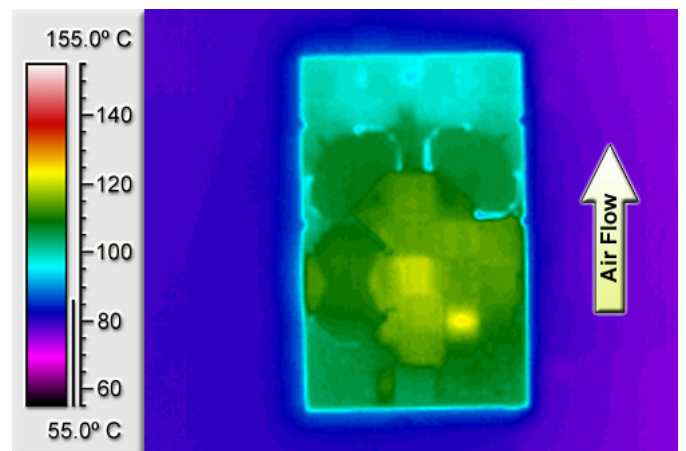

Figure 12: Thermal plot of converter at 4.2 amp load current with 85°C air flowing at the rate of 200 LFM. Air is flowing across the converter from input to output (48V input).

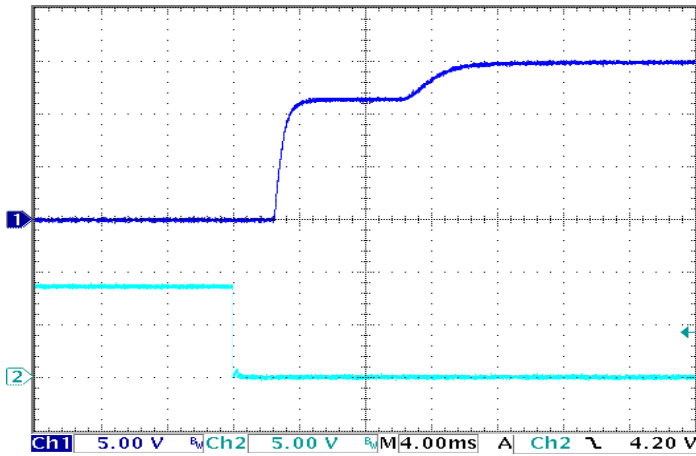

Figure 13: Turn-on transient at full load (resistive load) (4 ms/div). Input voltage pre-applied. Ch 1: Vout (5V/div). Ch 2: ON/OFF input (5V/div).

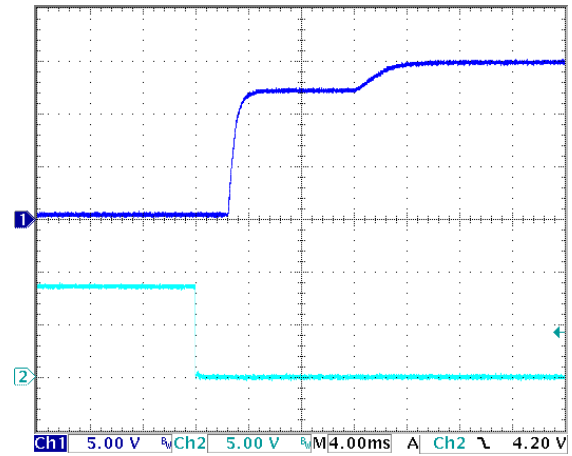

Figure 14: Turn-on transient at zero load (4 ms/div). Ch 1: Vout (5V/div). Ch 2: ON/OFF input (5V/div).

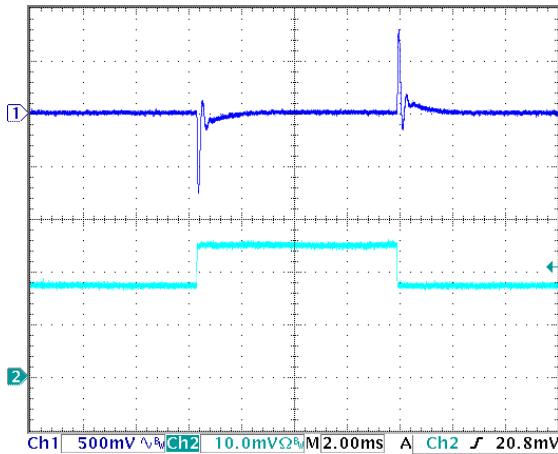

Figure 15: Output voltage response to step-change in load current (50%-75%-50% of Iout(max); $dI/dt = 0.1A/\mu s$). Load cap: 10 μF , 100 m Ω ESR tantalum cap and 1 μF ceramic cap. Ch 1: Vout (500mV/div), Ch 2: Iout (2A/div).

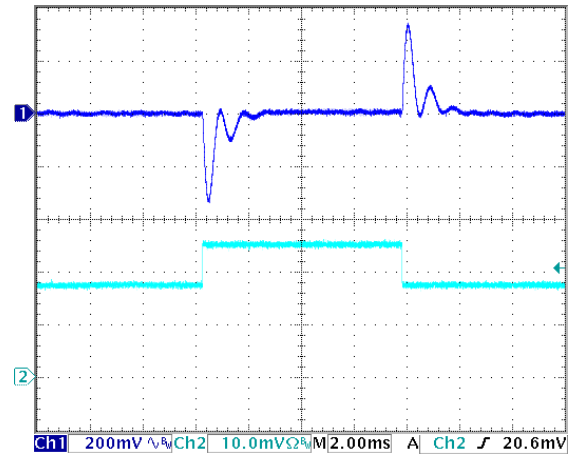

Figure 16: Output voltage response to step-change in load current (50%-75%-50% of Iout(max); $dI/dt = 5A/\mu s$). Load cap: 470 μF , 30m Ω ESR tantalum cap and 1 μF ceramic cap. Ch 1: Vout (200mV/div), Ch 2: Iout (2A/div).

See Fig. 19

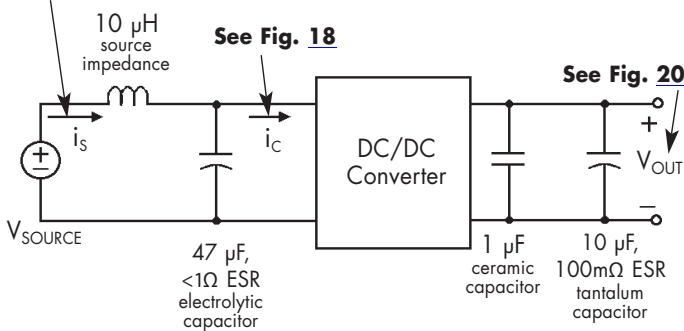

Figure 17: Test set-up diagram showing measurement points for Input Terminal Ripple Current (Fig 18), Input Reflected Ripple Current (Fig 19) and Output Voltage Ripple (Fig 20).

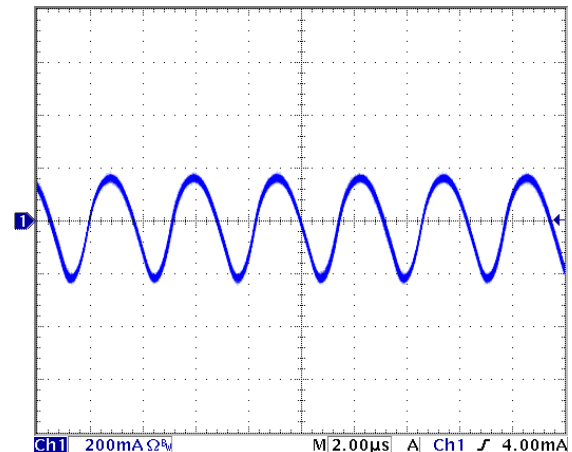

Figure 18: Input Terminal Ripple Current, i_c , at full rated output current and nominal input voltage with 10 μH source impedance and 47 μF electrolytic capacitor (200mA/div). See Figure 17.

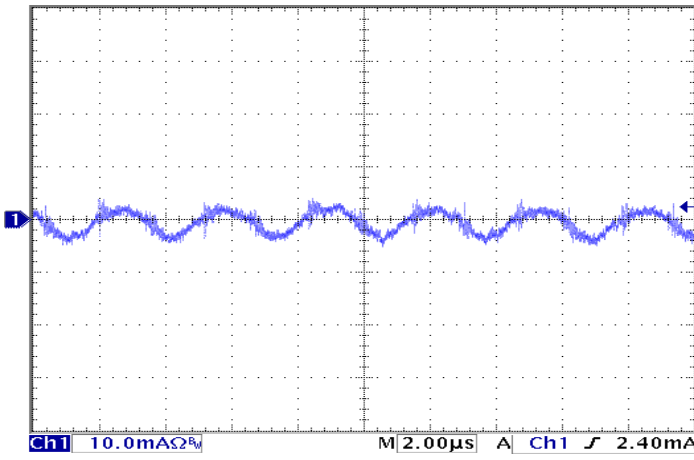

Figure 19: Input reflected ripple current, is, through a 10 μ H source inductor at nominal input voltage and rated load current (10mA/div). See Figure 17.

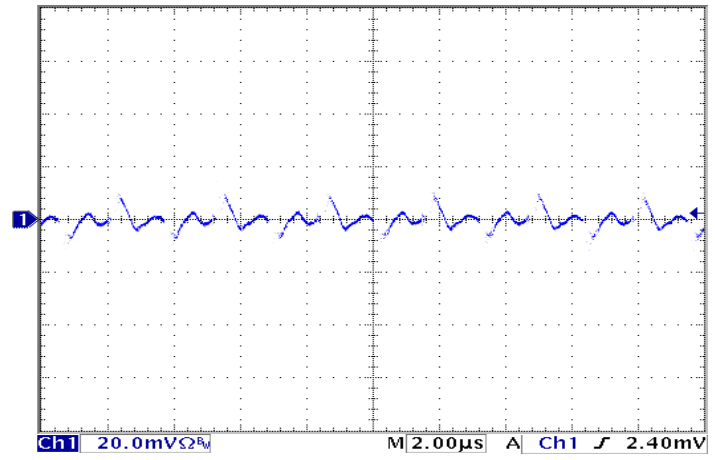

Figure 20: Output voltage ripple at nominal input voltage and rated load current (20mV/div). Load capacitance: 1 μ F ceramic capacitor and 10 μ F tantalum capacitor. Bandwidth: 20MHz. See Figure 17.

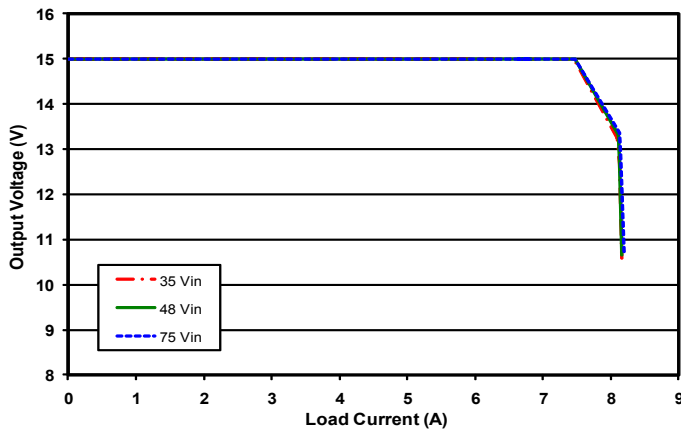

Figure 21: Output voltage vs. load current showing typical current limit curves and converter shutdown points.

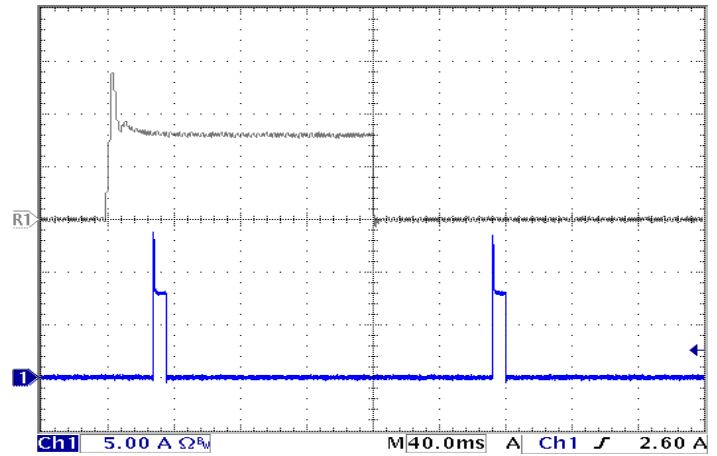

Figure 22: Load current (5A/div) as a function of time when the converter attempts to turn on into a 10 mW short circuit. Top trace (40ms/div) is an expansion of the on-time portion of the bottom trace.

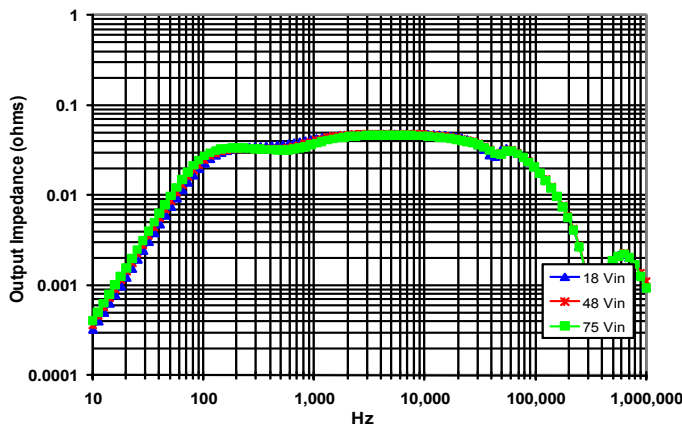

Figure 23: Magnitude of incremental output impedance ($Z_{out} = v_{out}/i_{out}$) for minimum, nominal, and maximum input voltage at full rated power.

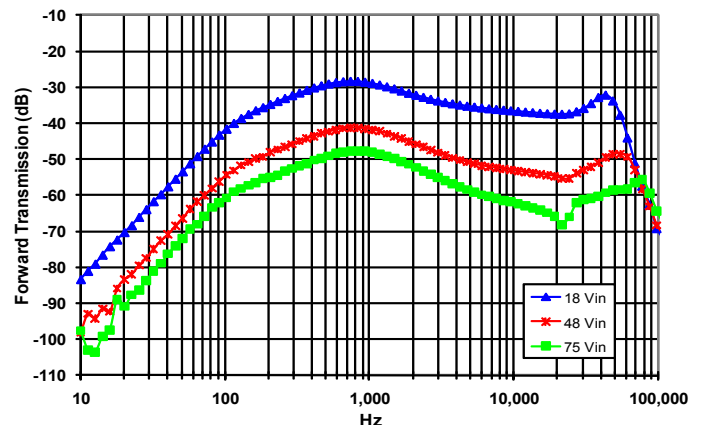

Figure 24: Magnitude of incremental forward transmission ($FT = v_{out}/v_{in}$) for minimum, nominal, and maximum input voltage at full rated power.

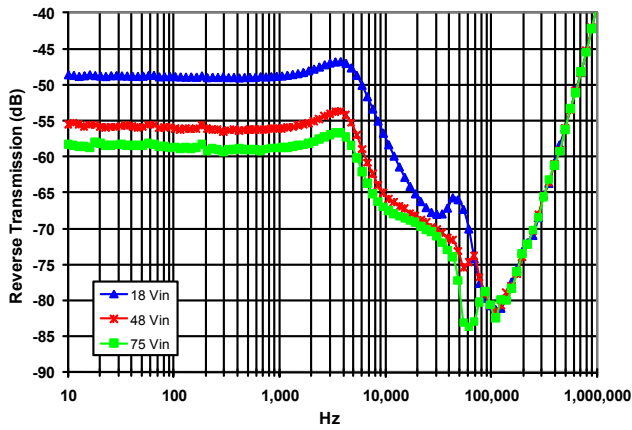

Figure 25: Magnitude of incremental reverse transmission ($RT = i_{in}/i_{out}$) for minimum, nominal, and maximum input voltage at full rated power.

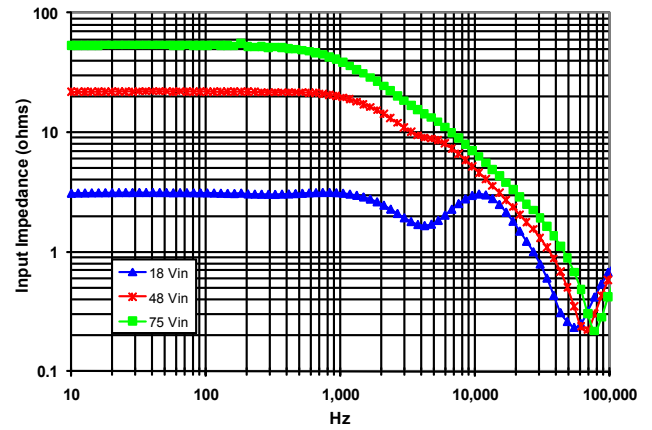

Figure 26: Magnitude of incremental input impedance ($Z_{in} = v_{in}/i_{in}$) for minimum, nominal, and maximum input voltage at full rated power.

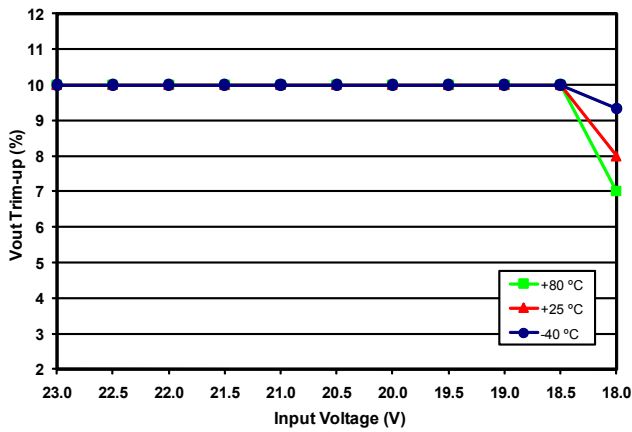

Figure 27: Achievable trim-up percentage vs. input voltage at $+85^{\circ}\text{C}$, $+25^{\circ}\text{C}$ and -40°C (all at full load). Full trim-up percentage is achieved at loads of 50% or less across full temperature and input voltage range.

BASIC OPERATION AND FEATURES

The **PowerQor** series converter uses a two-stage power conversion topology. The first stage is a buck-converter that keeps the output voltage constant over variations in line, load, and temperature. The second stage uses a transformer to provide the functions of input/output isolation and voltage step-down to achieve the low output voltage required.

Both the first stage and the second stage switch at a fixed frequency for predictable EMI performance. Rectification of the transformer's output is accomplished with synchronous rectifiers. These devices, which are MOSFETs with a very low on-state resistance, dissipate far less energy than Schottky diodes. This is the primary reason that the **PowerQor** converter has such high efficiency, even at very low output voltages and very high output currents.

Dissipation throughout the converter is so low that it does not require a heatsink for operation. Since a heatsink is not required, the **PowerQor** converter does not need a metal baseplate or potting material to help conduct the dissipated energy to the heatsink. The **PowerQor** converter can thus be built more simply and reliably using high yield surface mount techniques on a PCB substrate.

The **PowerQor** series of half-brick and quarter-brick converters uses the industry standard footprint and pin-out configuration.

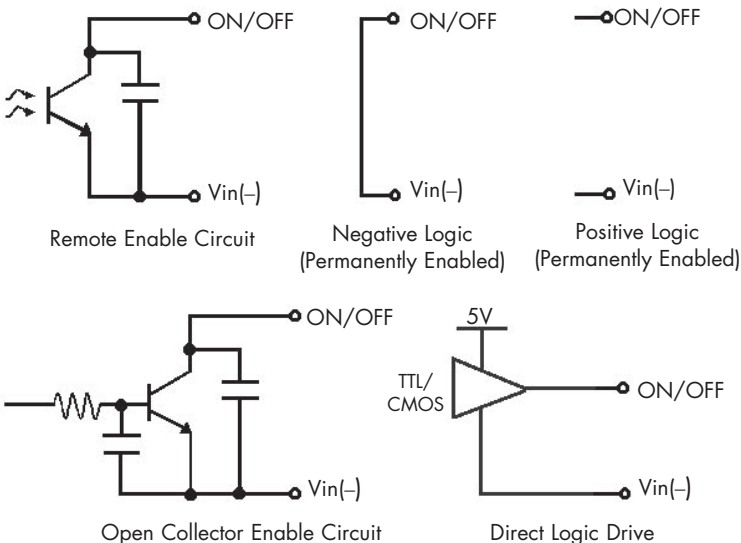

Figure A: Various circuits for driving the ON/OFF pin.

CONTROL FEATURES

REMOTE ON/OFF (Pin 2): The ON/OFF input, Pin 2, permits the user to control when the converter is **on** or **off**. This input is referenced to the return terminal of the input bus, Vin(-). There are two versions of the converter that differ by the sense of the logic used for the ON/OFF input.

In the positive logic version, the ON/OFF input is active high (meaning that a high turns the converter **on**). In the negative logic version, the ON/OFF signal is active low (meaning that a low turns the converter **on**). Figure A details five possible circuits for driving the ON/OFF pin. Figure B is a detailed look of the internal ON/OFF circuitry.

REMOTE SENSE(±) (Pins 7 and 5): The SENSE(±) inputs correct for voltage drops along the conductors that connect the converter's output pins to the load.

Pin 7 should be connected to Vout(+) and Pin 5 should be connected to Vout(-) at the point on the board where regulation is desired. A remote connection at the load can adjust for a voltage drop only as large as that specified in this datasheet, that is

$$\frac{[V_{out(+)} - V_{out(-)}] - [V_{sense(+)} - V_{sense(-)}]}{V_{out}} \leq \text{Sense Range \%} \times V_{out}$$

Pins 7 and 5 must be connected for proper regulation of the output voltage. If these connections are not made, the converter will deliver an output voltage that is slightly higher than its specified value.

Note: the output over-voltage protection circuit senses the voltage across the output (pins 8 and 4) to determine when it should trigger, not the voltage across the converter's sense leads (pins 7 and 5). Therefore, the resistive drop on the board should be small enough so that output OVP does not trigger, even during load transients.

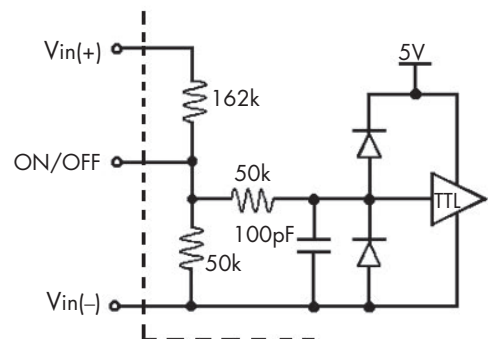

Figure B: Internal ON/OFF pin circuitry

OUTPUT VOLTAGE TRIM (Pin 6): The TRIM input permits the user to adjust the output voltage across the sense leads up or down according to the trim range specifications.

To decrease the output voltage, the user should connect a resistor between Pin 6 and Pin 5 (SENSE(-) input). For a desired decrease of the nominal output voltage, the value of the resistor should be

$$R_{\text{trim-down}} = \left(\frac{511}{\Delta\%} \right) - 10.22 \text{ (k}\Omega\text{)}$$

where

$$\Delta\% = \left| \frac{V_{\text{nominal}} - V_{\text{desired}}}{V_{\text{nominal}}} \right| \times 100\%$$

To increase the output voltage, the user should connect a resistor between Pin 6 and Pin 7 (SENSE(+) input). For a desired increase of the nominal output voltage, the value of the resistor should be

$$R_{\text{trim-up}} = \left(\frac{5.11V_{\text{OUT}}(100+\Delta\%)}{1.225\Delta\%} - \frac{511}{\Delta\%} - 10.22 \right) \text{ (k}\Omega\text{)}$$

where

$$V_{\text{OUT}} = \text{Nominal Output Voltage}$$

Figure C graphs the relationship between the trim resistor value and R_{trim-up} and R_{trim-down}, showing the total range the output voltage can be trimmed up or down.

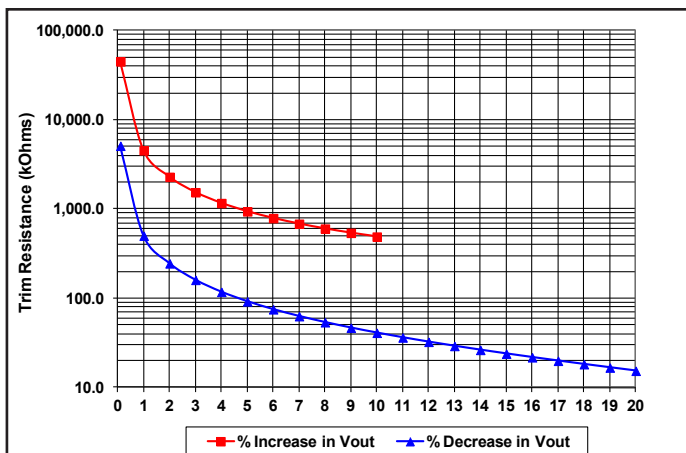

Figure C: Trim Graph

Note: the TRIM feature does not affect the voltage at which the output over-voltage protection circuit is triggered. Trimming the output voltage too high may cause the over-voltage protection circuit to engage, particularly during transients.

It is not necessary for the user to add capacitance at the Trim pin. The node is internally bypassed to eliminate noise.

Total DC Variation of V_{out}: For the converter to meet its full specifications, the maximum variation of the DC value of V_{out}, due to both trimming and remote load voltage drops, should not be greater than that specified for the output voltage trim range.

PROTECTION FEATURES

Input Under-Voltage Lockout: The converter is designed to turn off when the input voltage is too low, helping avoid an input system instability problem, described in more detail in the application note titled "Input System Instability". The lockout circuitry is a comparator with DC hysteresis. When the input voltage is rising, it must exceed the typical Turn-On Voltage Threshold value (listed on the specification page) before the converter will turn on. Once the converter is on, the input voltage must fall below the typical Turn-Off Voltage Threshold value before the converter will turn off.

Output Current Limit: The maximum current limit remains constant as the output voltage drops. However, once the impedance of the short across the output is small enough to make the output voltage drop below the specified Output DC Current-Limit Shutdown Voltage, the converter turns off.

The converter then enters a "hiccup mode" where it repeatedly turns on and off at a 5 Hz (nominal) frequency with a 5% duty cycle until the short circuit condition is removed. This prevents excessive heating of the converter or the load board.

Output Over-Voltage Limit: If the voltage across the output pins exceeds the Output Over-Voltage Protection threshold, the converter will immediately stop switching. This prevents damage to the load circuit due to 1) excessive series resistance in output current path from converter output pins to sense point, 2) a release of a short-circuit condition, or 3) a release of a current limit condition. Load capacitance determines exactly how high the output voltage will rise in response to these conditions. After 200 ms the converter will automatically restart.

Over-Temperature Shutdown: A temperature sensor on the converter senses the average temperature of the module. The thermal shutdown circuit is designed to turn the converter off when the temperature at the sensed location reaches the Over-Temperature Shutdown value. It will allow the converter to turn on again when the temperature of the sensed location falls by the amount of the Over-Temperature Shutdown Restart Hysteresis value.

APPLICATION CONSIDERATIONS

Input System Instability: This condition can occur because any DC/DC converter appears incrementally as a negative resistance load. A detailed application note titled "Input System Instability" is available on the SynQor website which provides an understanding of why this instability arises, and shows the preferred solution for correcting it.

Application Circuits: Figure D below provides a typical circuit diagram which details the input filtering and voltage trimming.

Input Filtering and External Capacitance: Figure E below provides a diagram showing the internal input filter components. This filter dramatically reduces input terminal ripple current, which otherwise could exceed the rating of an external electrolytic input capacitor. The recommended external input capacitance is specified in the "Input Characteristics" section. More detailed information is available in the application note titled "EMI Characteristics" on the SynQor website.

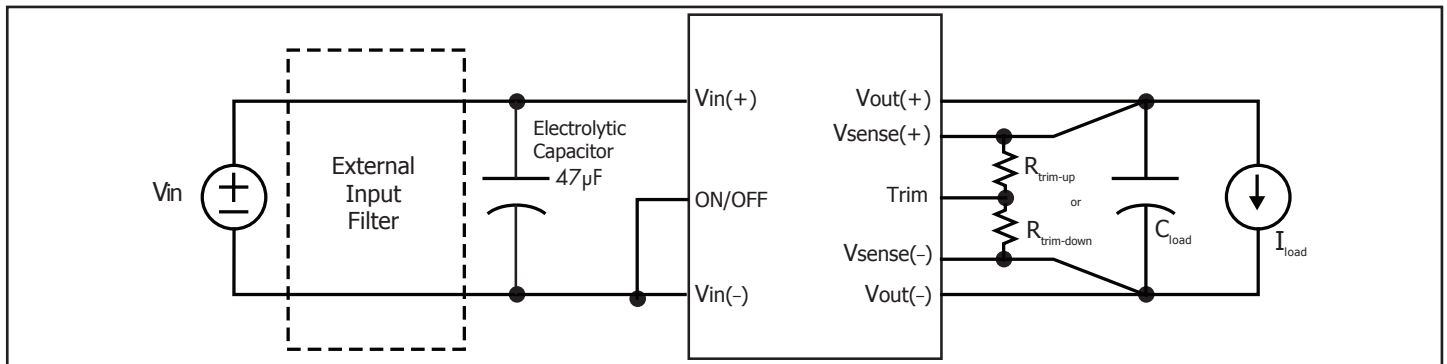

Figure D: Typical application circuit (negative logic unit, permanently enabled).

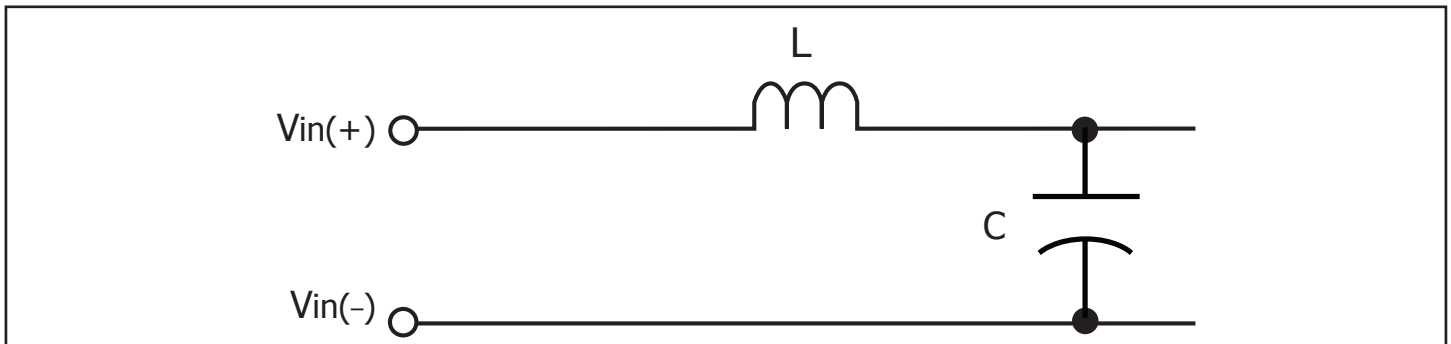

Figure E: Internal Input Filter Diagram (component values listed on page 3).

Startup Inhibit Period: The Startup Inhibit Period ensures that the converter will remain off for approximately 200ms when it is shut down for any reason. When an output short is present, this generates a 5Hz "hiccup mode," which prevents the converter from overheating. In all, there are seven ways that the converter can be shut down, initiating a Startup Inhibit Period:

- Input Under-Voltage Lockout
- Input Over-Voltage Shutdown (not present in Quarter-brick)
- Output Over-Voltage Protection
- Over Temperature Shutdown
- Current Limit
- Short Circuit Protection
- Turned off by the ON/OFF input

Figure F shows three turn-on scenarios, where a Startup Inhibit Period is initiated at t_0 , t_1 , and t_2 :

Before time t_0 , when the input voltage is below the UVL threshold, the unit is disabled by the Input Under-Voltage Lockout feature. When the input voltage rises above the UVL threshold, the Input Under-Voltage Lockout is released, and a Startup Inhibit Period is initiated. At the end of this delay, the ON/OFF pin is evaluated, and since it is active, the unit turns on.

At time t_1 , the unit is disabled by the ON/OFF pin, and it cannot be enabled again until the Startup Inhibit Period has elapsed.

When the ON/OFF pin goes high after t_2 , the Startup Inhibit Period has elapsed, and the output turns on within the typical Turn-On Time.

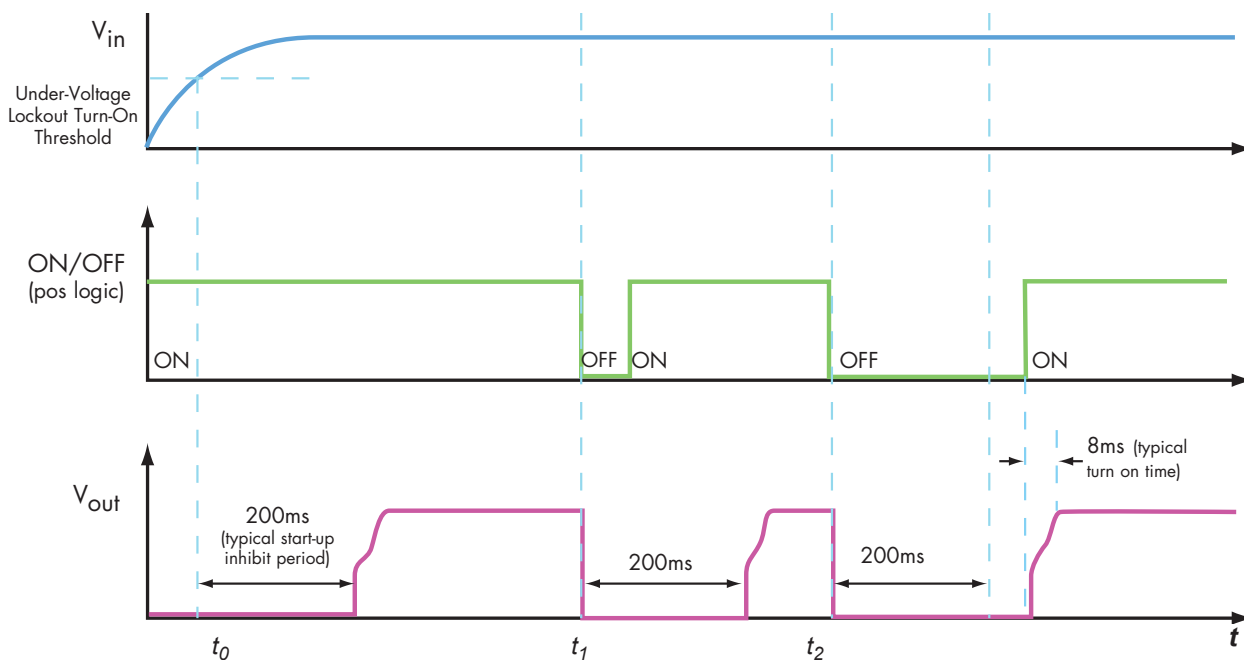

Figure F: Startup Inhibit Period (turn-on time not to scale)



Standards and Qualifications

Input: 18-75V
Output: 15V
Current: 6.67A
Package: Quarter-brick

Parameter	Notes & Conditions
-----------	--------------------

STANDARDS COMPLIANCE

CAN/CSA C22.2 No. 60950-1

UL 60950-1

EN 60950-1

Note: An external input fuse must always be used to meet these safety requirements. Contact SynQor for official safety certificates on new releases or download from the SynQor website.

Parameter	# Units	Test Conditions
-----------	---------	-----------------

QUALIFICATION TESTING

Life Test	32	95% rated Vin and load, units at derating point, 1000 hours
Vibration	5	10-55 Hz sweep, 0.060" total excursion, 1 min./sweep, 120 sweeps for 3 axis
Mechanical Shock	5	100 g minimum, 2 drops in x, y and z axis
Temperature Cycling	10	-40 °C to 100 °C, unit temp. ramp 15 °C/min., 500 cycles
Power/Thermal Cycling	5	Toperating = min to max, Vin = min to max, full load, 100 cycles
Design Marginality	5	Tmin-10 °C to Tmax+10 °C, 5 °C steps, Vin = min to max, 0-105% load
Humidity	5	85 °C, 95% RH, 1000 hours, continuous Vin applied except 5 min/day
Solderability	15 pins	MIL-STD-883, method 2003



Ordering Information

Input: 18-75V
Output: 15V
Current: 6.67A
Package: Quarter-brick

PART NUMBERING SYSTEM

The part numbering system for SynQor's dc-dc converters follows the format shown in the example below.

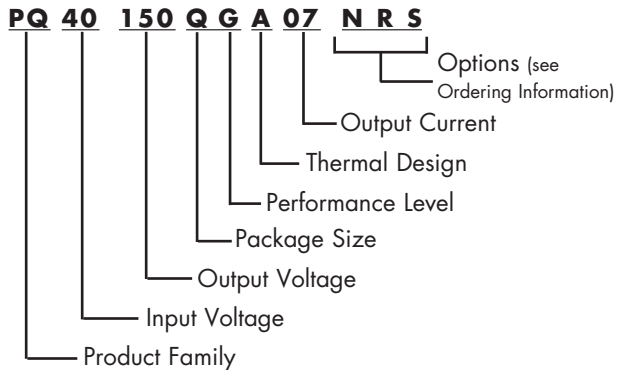

Application Notes

A variety of application notes and technical white papers can be downloaded in pdf format from our website.

RoHS Compliance: The EU led RoHS (Restriction of Hazardous Substances) Directive bans the use of Lead, Cadmium, Hexavalent Chromium, Mercury, Polybrominated Biphenyls (PBB), and Polybrominated Diphenyl Ether (PBDE) in Electrical and Electronic Equipment. This SynQor product is 6/6 RoHS compliant. For more information please refer to SynQor's RoHS addendum available at our [RoHS Compliance / Lead Free Initiative web page](#) or e-mail us at rohs@synqor.com.

Contact SynQor for further information and to order:

Phone: 978-849-0600
Toll Free: 888-567-9596
Fax: 978-849-0602
E-mail: power@synqor.com
Web: www.synqor.com
Address: 155 Swanson Road
 Boxborough, MA 01719
 USA

ORDERING INFORMATION

The tables below show the valid model numbers and ordering options for converters in this product family. When ordering SynQor converters, please ensure that you use the complete 15 character part number consisting of the 12 character base part number and the additional characters for options. Add "-G" to the model number for 6/6 RoHS compliance.

The following options must be included in place of the **wxyz** spaces in the model numbers listed above.

Options Description: wxyz			
Thermal Design	Enable Logic	Pin Style	Feature Set
A - Open Frame B - Baseplated	N - Negative P - Positive	K - 0.110" N - 0.145" R - 0.180" Y - 0.250"	S - Standard

Not all combinations make valid part numbers, please contact SynQor for availability.

Model Number	Input Voltage Range	Output Voltage	Max Output Current
PQ40150QGw07xyz	18-75V	15V	6.67A
PQ40120QGw08xyz	18-75V	12 V	8.33 A
PQ40080QGw09xyz	18-75V	8.0 V	9.0A
PQ40050QGw20xyz	18-75V	5.0 V	20 A
PQ40033QGw25xyz	18-75V	3.3 V	25 A

PATENTS

SynQor holds numerous U.S. patents, one or more of which apply to most of its power conversion products. Any that apply to the product(s) listed in this document are identified by markings on the product(s) or on internal components of the product(s) in accordance with U.S. patent laws. SynQor's patents include the following:

6,545,890 6,894,468 6,896,526 6,927,987 7,050,309 7,085,146
 7,119,524 7,765,687 7,787,261 8,149,597 8,644,027

WARRANTY

SynQor offers a three (3) year limited warranty. Complete warranty information is listed on our website or is available upon request from SynQor.